

ZDIR

Přístrojové zdirky \varnothing 4mm

obj. č.	objednávací název
■ 42850	ZDIR - 123 CERNÁ
■ 42851	ZDIR - 123 CERVENÁ
■ 00084	ZDIR - 125 CERNÁ
■ 00085	ZDIR - 125 CERVENÁ
■ 00089	ZDIR - 313 CERNÁ
■ 00091	ZDIR - 313 CERVENÁ
■ 00093	ZDIR - 72D CERNÁ
■ 00095	ZDIR - 72D CERVENÁ
■ 00096	ZDIR - 72D MODRÁ
■ 00098	ZDIR - 72D ZELENÁ
■ 00101	ZDIR - 72D ZLUTÁ
# 17397	ZDIR - 73 BILÁ
■ 17398	ZDIR - 73 CERNÁ
08128	ZDIR - 73 CERVENÁ
08135	ZDIR - 73 MODRÁ
08137	ZDIR - 73 ZELENÁ
08138	ZDIR - 73 ZLUTÁ



ZDIR - 123

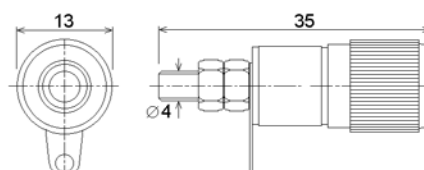

ZDIR - 125

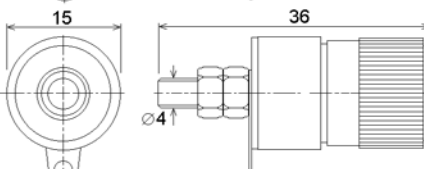

ZDIR - 313

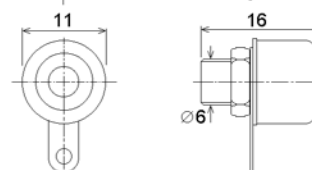

ZDIR - 73

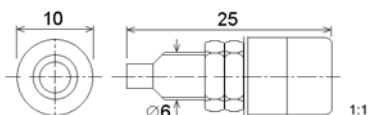

ZDIR - 72D

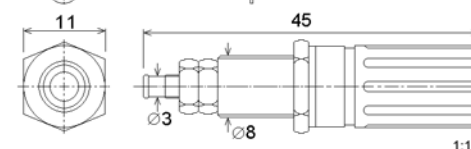

BAN

Banánky \varnothing 4mm

obj. č.	objednávací název	montáž vodiče
■ 00406	BAN - 364S CERNÁ	šroubkem
■ 16227	BAN - 364S CERVENÁ	šroubkem
■ 56426	BAN - 364S MODRÁ	šroubkem
■ 17042	BAN - 364S ZELENÁ	šroubkem
■ 56425	BAN - 364S ZLUTÁ	šroubkem
■ 19616	BAN - 364P CERNÁ	pájením
■ 19617	BAN - 364P CERVENÁ	pájením



BAN - 364

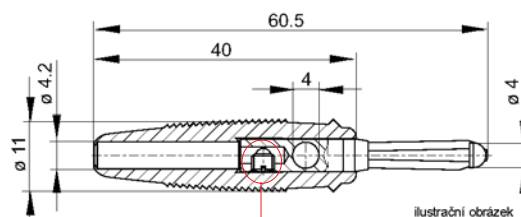

verze 364S se šroubkem

verze 364P je pájecí, bez šroubku

MH

Měřicí hroty na banánek

obj. č.	objednávací název
■ 17969	MH01 - CERNÁ
■ 17970	MH01 - CERVENÁ
# 17971	MH01 - MODRÁ
# 17972	MH01 - ZELENÁ



MH01 délka cca 100mm



KSVIZ

Krokosvorky izolované

obj. č.	objednávací název	délka
■ 42835	KSVIZ - 103A -C CERNÁ	
■ 42833	KSVIZ - 103A -C CERVENÁ	
■ 42838	KSVIZ - 103A -C MODRÁ	
■ 42837	KSVIZ - 103A -C ZELENÁ	
■ 42836	KSVIZ - 103A -C ZLUTÁ	
# 42840	KSVIZ - 105A -C CERNÁ	cca45mm
# 42839	KSVIZ - 105A -C CERVENÁ	cca45mm
■ 42841	KSVIZ - 110A -C CERNÁ	cca55mm
■ 42842	KSVIZ - 110A -C CERVENÁ	cca55mm
■ 42843	KSVIZ - 110A -C ZELENÁ	cca55mm
■ 14412	KSVIZ - B30L CERNÁ	cca80mm
■ 14413	KSVIZ - B30L CERVENÁ	cca80mm

KSVIZ - 103A



KSVIZ - 105A



KSVIZ - 110A



KSVIZ - B30L



KNAP VK

Napájecí sousé konektory, zásuvky na kabel

novinka!

obj. č.	objednávací název	d	D	L	A	B
27582	KNAPVK-07 PN-1	0.7	2.35	9.5	8	18
27583	KNAPVK-10 PN-1	1.0	3.8	9.0	9	21.3
■	00066	1.3	3.5	9.5	8	18
■	00067	2.1	5.4	9.5	8	18
■	00068	2.1	5.4	14.0	8	18
■	00072	2.5	5.4	9.5	8	18
■	00076	2.5	5.4	14.0	8	18

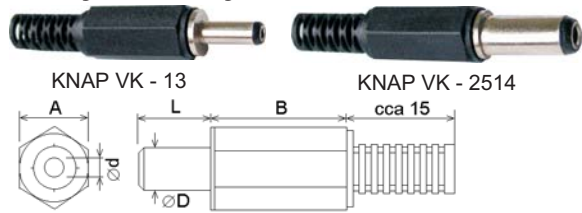

KNAP ZP

Napájecí sousé konektory, vidlice na panel

obj. č.	objednávací název	D (mm)
■	14929	2.0
■	14361	2.0
#	42817	2.1
#	42810	2.5
#	42816	2.5
■	00079	2.5
#	30693	2.5

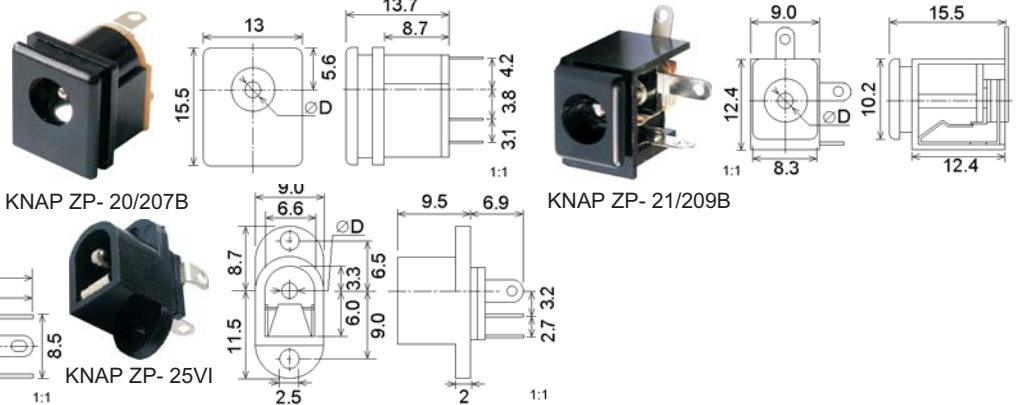

KNAP ZPS

Napájecí sousé konektory, vidlice do plošného spoje

novinka!

obj. č.	objednávací název	D (mm)	montáž	obr.
27590	KNAPZPS-07CVY-1	0.7	THT	6
■	51391	1.0	THT	1
■	05830	1.0	THT	2
■	42818	1.3	THT	1
■	05827	1.3	THT	2
#	00017	1.3	THT	3
■	27591	2.0	THT	4
■	27592	2.5	THT	4
■	08160	2.0	páj. očka	5
■	07378	2.5	páj. očka	5
■	27588	1.0	SMD	7
■	27589	1.3	SMD	7
■	27585	2.0	SMD	8
■	27587	2.5	SMD	8

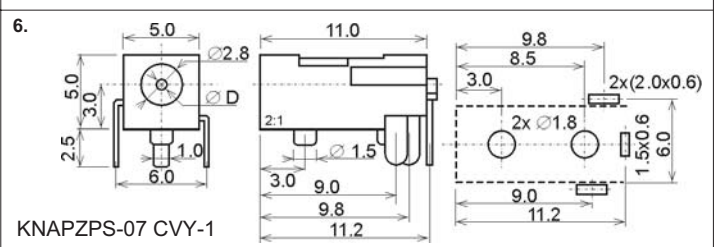
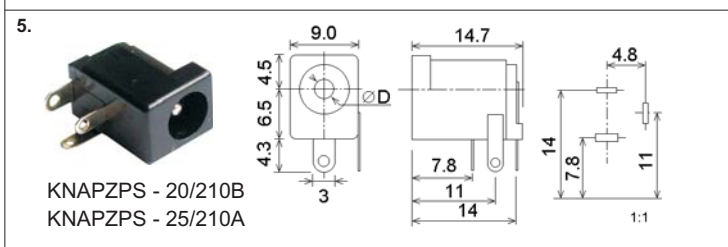
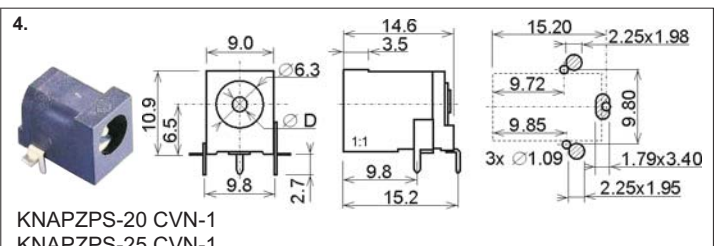
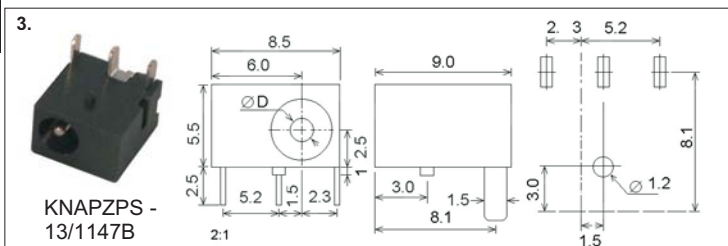
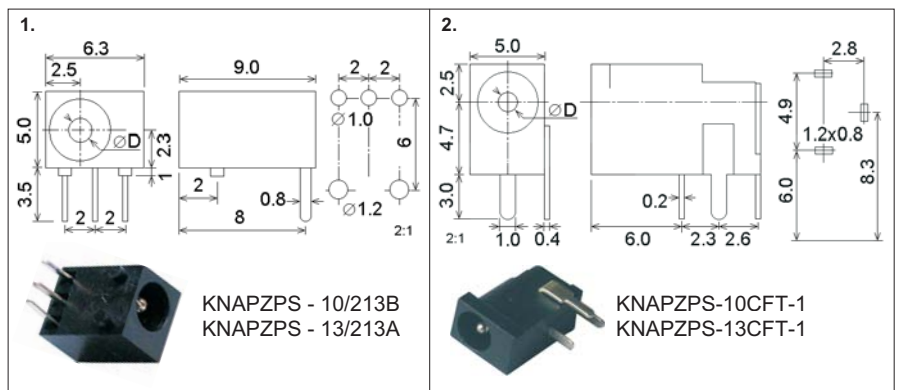

■ součástka se doplňuje na sklad

součástka na skladě, výprodej

Dodací podmínky neoznačených součástek sdělíme na požádání

KONEKTORY NAPÁJECÍ

pokračování obrázků ze strany 50.22

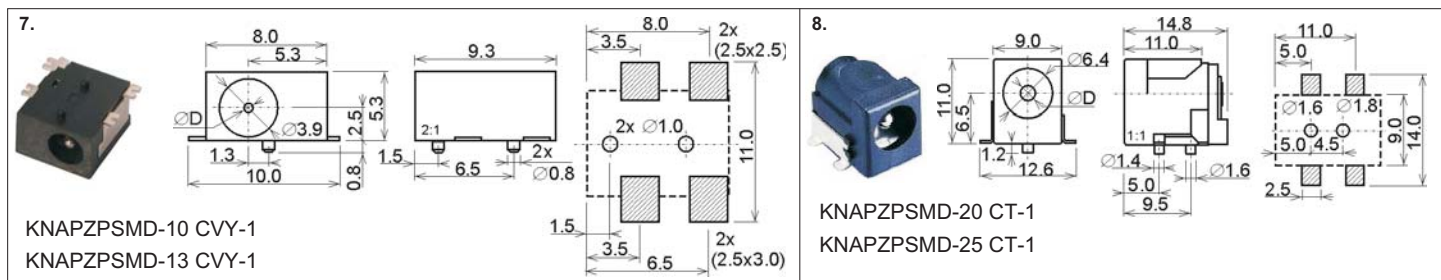

ACZV

Vidlice do zásuvky v automobilu

obj. č.	objednávací název	popis
00002	ACZV - 100	vidlice na kabel

ACZV - 100



délka cca 70 mm

SK, SP

Síťové zásuvky a vidlice 250V

obj. č.	objednávací název	popis	I (A)
16945	SKV - 1	vidlice na kabel	10
17386	SKZ - 1	zásuvka na kabel	1
17569	SKZ - 2	zásuvka na kabel	10
00023	SPV - 150	vidlice na panel	10
00025	SPV - WTN02 1181	vidlice na panel	6
00024	SPV - WTN02 1171R1-1	vidlice na panel	6
00109	SPV - WTN02 1182	vidlice na panel	15
00105	SPV - WTN02 1171R1	vidlice na panel	15
# 42740	SPV - M01SB02US	vidlice na panel	2.5
17385	SPZ - 250	zásuvka na panel	10



SPV-WTN02-1182

